

# ASSEMBLY INSTRUCTION

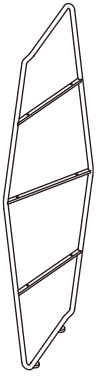

Ax1

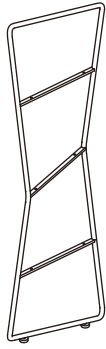

Bx1



Cx2



Dx1



Ex12

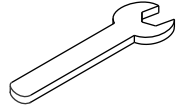

Fx1

1



2

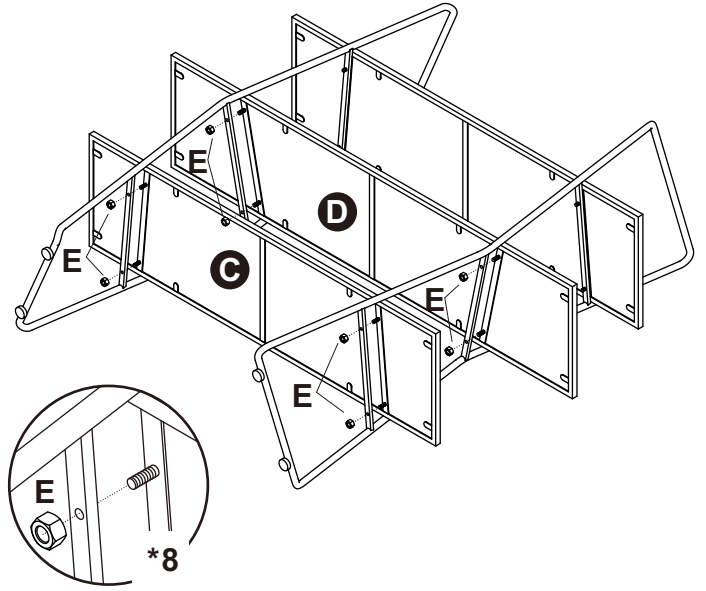
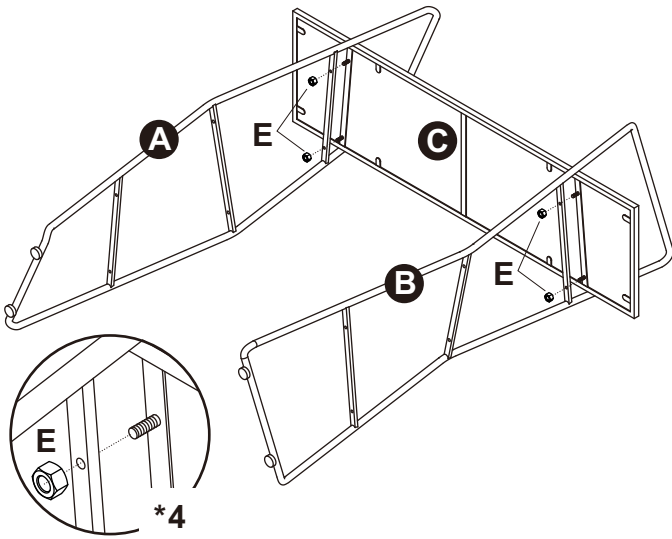

3



4

